

MODEL	SPECIFICATION Rotary Coded Switch RoHS&REACH Compliant / Halogen Free	SP-001	Page
R9 Series SMD Type			1/8

Order Information:

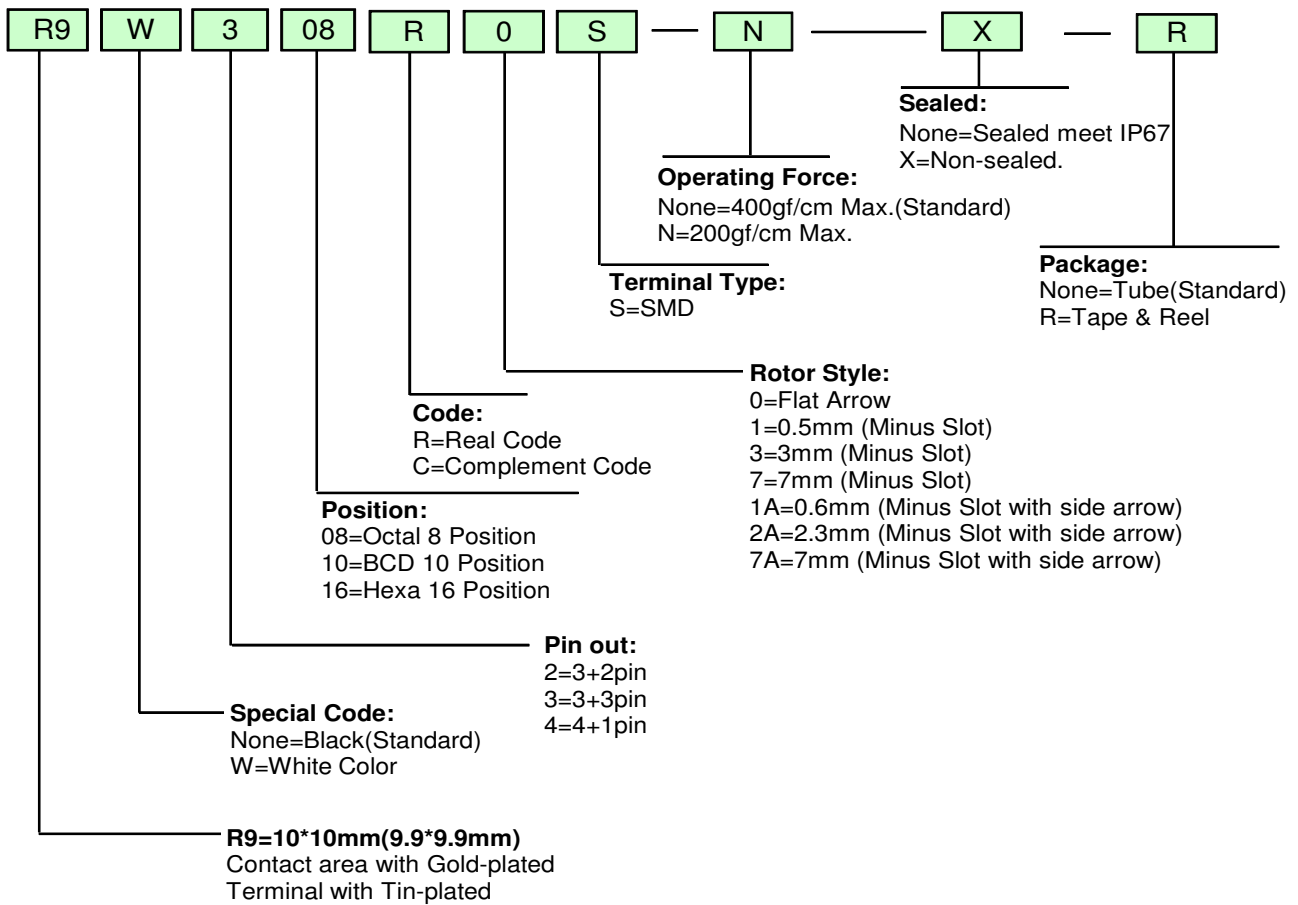

Knob order information

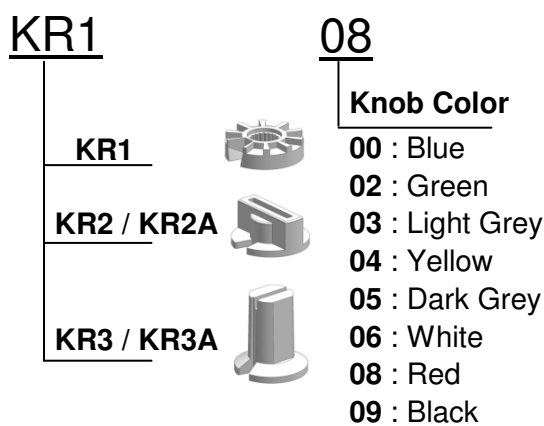

Note:

1. All knobs are not allowed to pass through the soldering process.
2. All knobs should be assembled after all soldering processes are finished.

MODEL	SPECIFICATION Rotary Coded Switch RoHS&REACH Compliant / Halogen Free	SP-003	Page
R9 Series SMD Type			3/8

Position

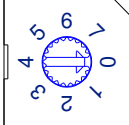
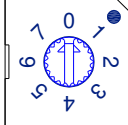
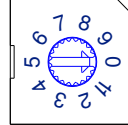
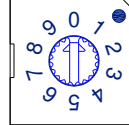
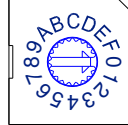
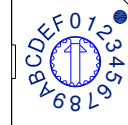
8 Position		10 Position		16 Position	
R92/93	R94	R92/93	R94	R92/93	R94
					

Rotor

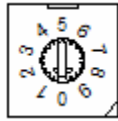

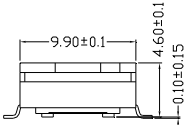
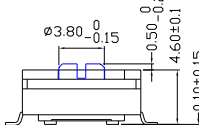
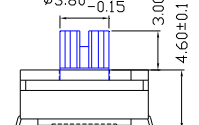
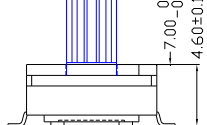
0 (Flat Type)	1 (0.5mm)	3 (3mm)	7 (7mm)
			

A Rotor

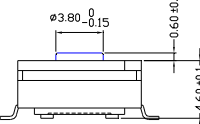
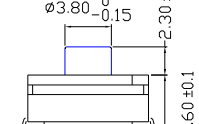
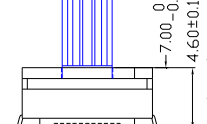

1A (0.6mm)	2A (2.3mm)	7A (7mm)
		

Rotor Color

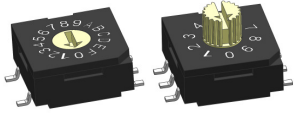
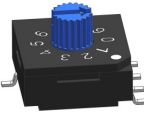
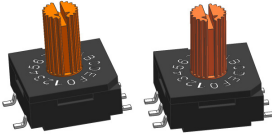
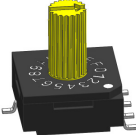
Real Code		Complement Code	
R93/R92 (White)	R94 (Blue)	R93/R92 (Orange)	R94 (Yellow)
			

MODEL R9 Series SMD Type	SPECIFICATION Rotary Coded Switch RoHS&REACH Compliant / Halogen Free	SP-004	Page 4/8
---	--	---------------	---------------------------

R92

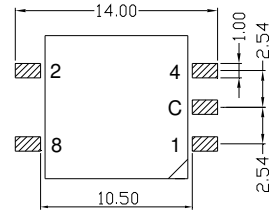
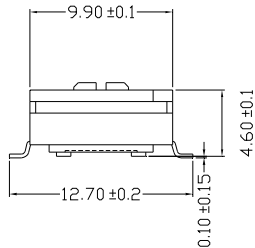
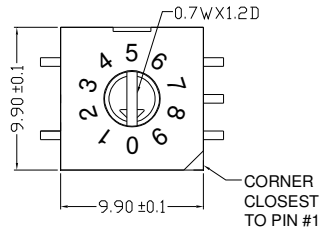
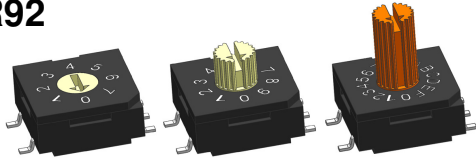

Solder pad layout as viewed from the top of the switch

R93

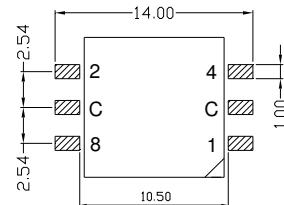
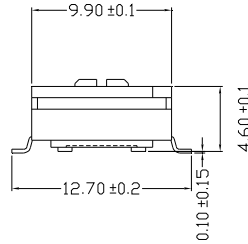
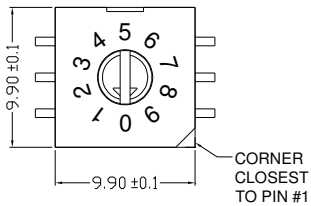
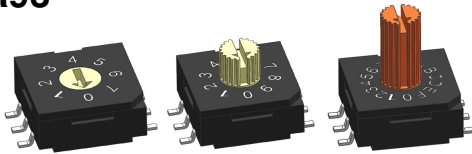

Solder pad layout as viewed from the top of the switch

R94

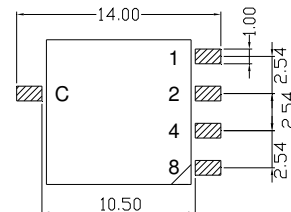
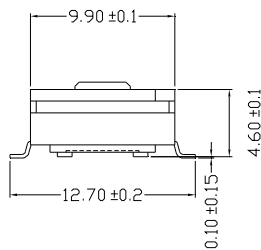
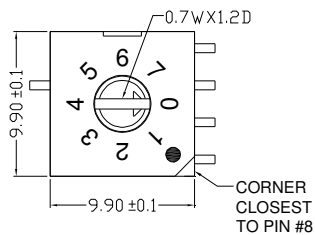
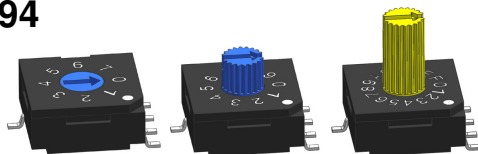

Solder pad layout as viewed from the top of the switch

MODEL	SPECIFICATION Rotary Coded Switch RoHS&REACH Compliant / Halogen Free	SP-005	Page
R9 Series			5/8
SMD Type			

R92-A Rotor

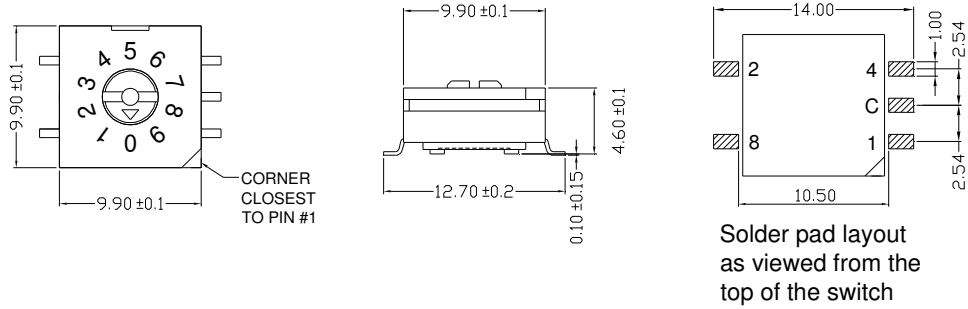

R93-A Rotor

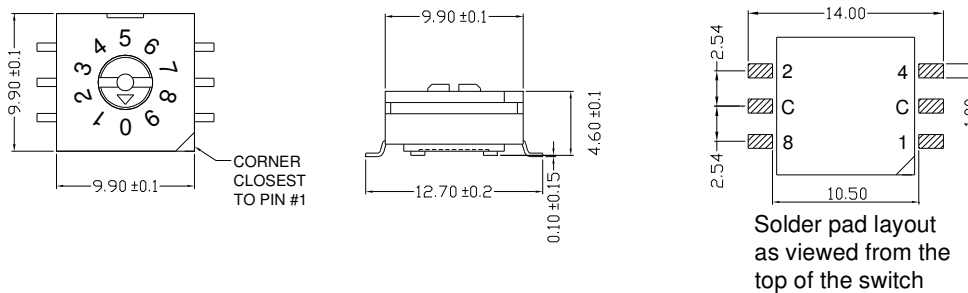

R94-A Rotor

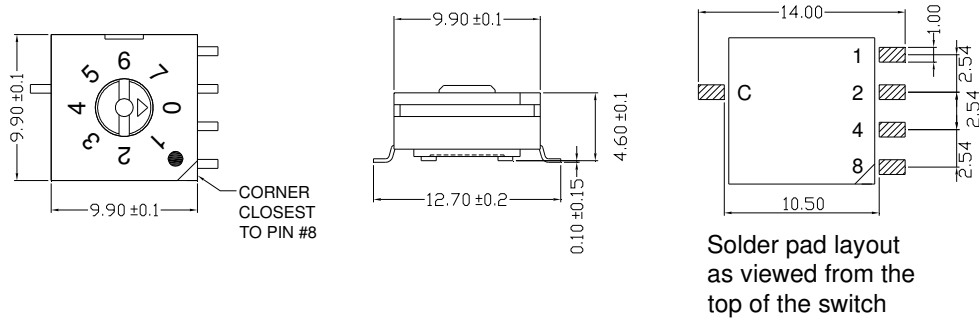

MODEL	SPECIFICATION Rotary Coded Switch RoHS&REACH Compliant / Halogen Free	SP-006	Page
R9 Series SMD Type			6/8

Soldering Information:

◆ **Hand Soldering**

Soldering iron of 30W or under at 350°C for 3 sec. max or at 270°C for 5 sec. max.

◆ **Reflow Soldering**

SMD type allows 1-time reflow soldering only.

Classification Reflow Profiles

Profile Feature	Pb-Free Assembly
Preheat / Soak	
Temperature Min (T _{smin})	150°C
Temperature Max (T _{smax})	200°C
Time(ts) from (T _{smin} to T _{smax})	60 ~120 seconds
Ramp-up Rate (T _L to T _p)	3°C/second max
Liquidous temperature (T _L)	217°C
Time (t _L) maintained above to T _L	60 ~ 150 seconds
Peak package body temperature (T _p)	For users T _p must not exceed the Classification temp:260°C (Package Thickness:1.6~2.5mm) For suppliers T _p must equal or exceed the Classification temp:260°C (Package Thickness:1.6~2.5mm)
Time (t _p) within 5°C of specified classification Temperature (T _c)	30 seconds
Ramp-Down Rate (T _p to T _L)	6°C/second max
Time 25°C to Peak Temperature	8 minutes max
* Tolerance for peak profile temperature(T _p) is defined as a supplier minimum and a user maximum	

Note 1: All temperatures refer to topside of the package, measured on the package body surface.

Note 2: Time within 5 °C of actual peak temperature (t_p) specified for the reflow profiles is a “supplier” minimum and “user” maximum.

Source: IPC/JEDEC J-STD-020 D.1

Recommended Reflow Soldering Conditions

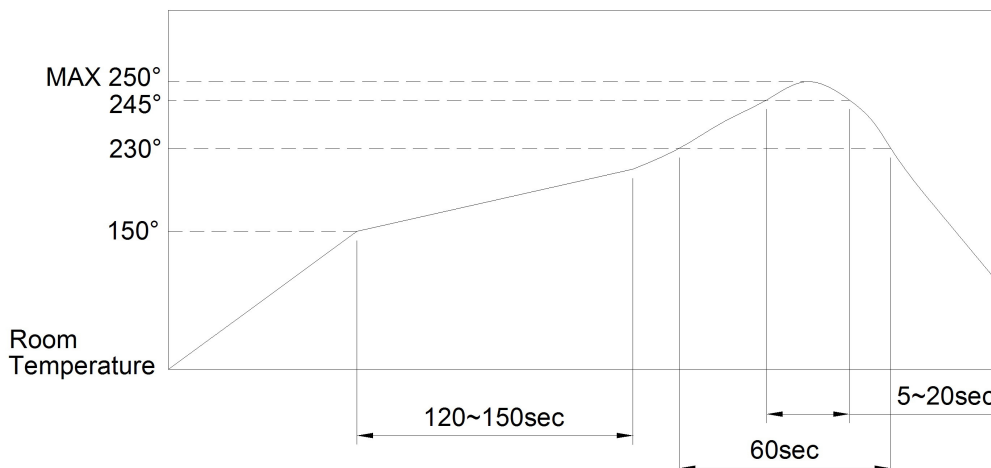

MODEL	SPECIFICATION Rotary Coded Switch RoHS&REACH Compliant / Halogen Free	SP-007	Page
R9 Series SMD Type			7/8

Part Number Table:

Pin Out	No. Pos.	Real Code			Complementary Code		
		S Type 0.5mm Rotor Tube Package	S Type 7mm Rotor Tube Package	S Type Flat Rotor Taping Reel	S Type 3mm Rotor Tube Package	S Type 7mm Rotor Tube Package	S Type 0.6mm Rotor Taping Reel
3+2	08	R9208R1S	R9208R7S	R9208R0S-R	R9208C3S	R9208C7S	R9208C1AS-R
	10	R9210R1S	R9210R7S	R9210R0S-R	R9210C3S	R9210C7S	R9210C1AS-R
	16	R9216R1S	R9216R7S	R9216R0S-R	R9216C3S	R9216C7S	R9216C1AS-R
3+3	08	R9308R1S	R9308R7S	R9308R0S-R	R9308C3S	R9308C7S	R9308C1AS-R
	10	R9310R1S	R9310R7S	R9310R0S-R	R9310C3S	R9310C7S	R9310C1AS-R
	16	R9316R1S	R9316R7S	R9316R0S-R	R9316C3S	R9316C7S	R9316C1AS-R
4+1	08	R9408R1S	R9408R7S	R9408R0S-R	R9408C3S	R9408C7S	R9408C1AS-R
	10	R9410R1S	R9410R7S	R9410R0S-R	R9410C3S	R9410C7S	R9410C1AS-R
	16	R9416R1S	R9416R7S	R9416R0S-R	R9416C3S	R9416C7S	R9416C1AS-R

Tube Package:

ROTOR	0mm ~7mm
Per TUBE (pcs)	50
BOX (pcs)	2000
CTN 1 (pcs)	4000
CTN 2 (pcs)	8000

Reel Package:

ROTOR	0 ~ 1mm	2 ~ 3mm	7mm
Per REEL (pcs)	600	350	200
BOX (pcs)	1800	1050	600
CTN 1 (pcs)	3600	2100	1200

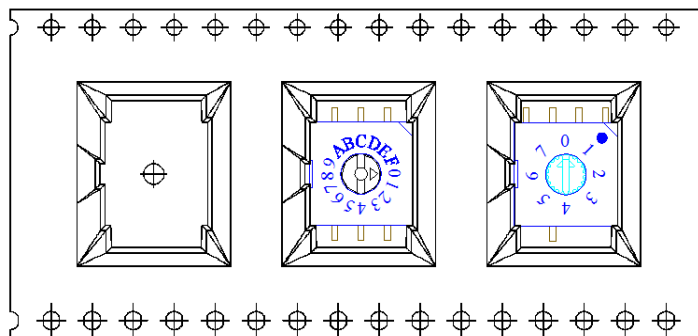
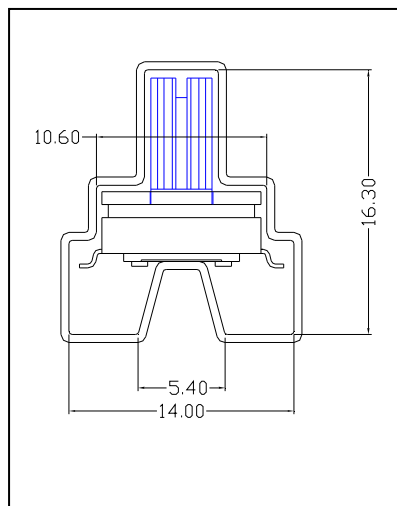

Carton:

- ◆ Tube 2 Boxes..... 58.5cm x 29.0cm x 15.0cm
- 4 Boxes..... 58.5cm x 28.0cm x 27.0cm
- ◆ Reel 2 Boxes..... 36.0cm x 27.5cm x 37.0cm

MODEL	SPECIFICATION Rotary Coded Switch RoHS&REACH Compliant / Halogen Free	SP-008	Page
R9 Series SMD Type			8/8

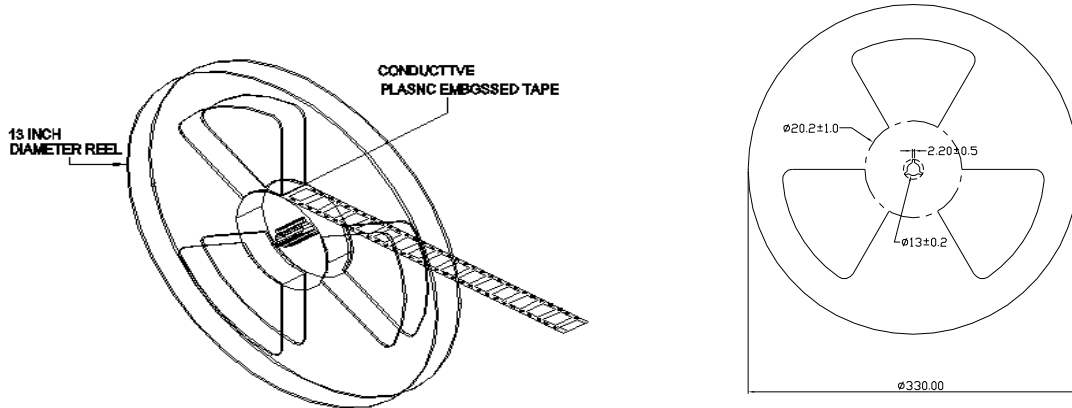
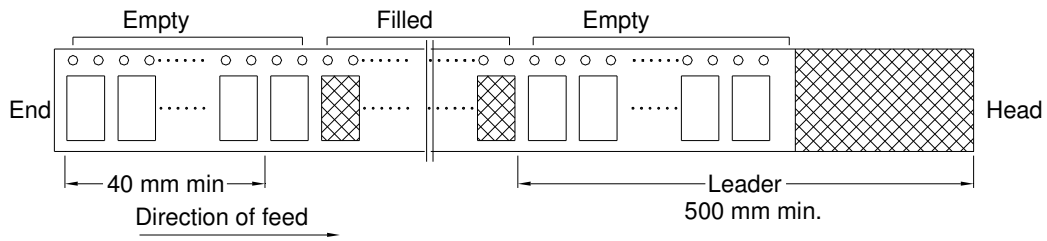

32mm

